

	WLW HEAD CILL SECTION C	Scale : 1.164
15/06/09	Box 851	

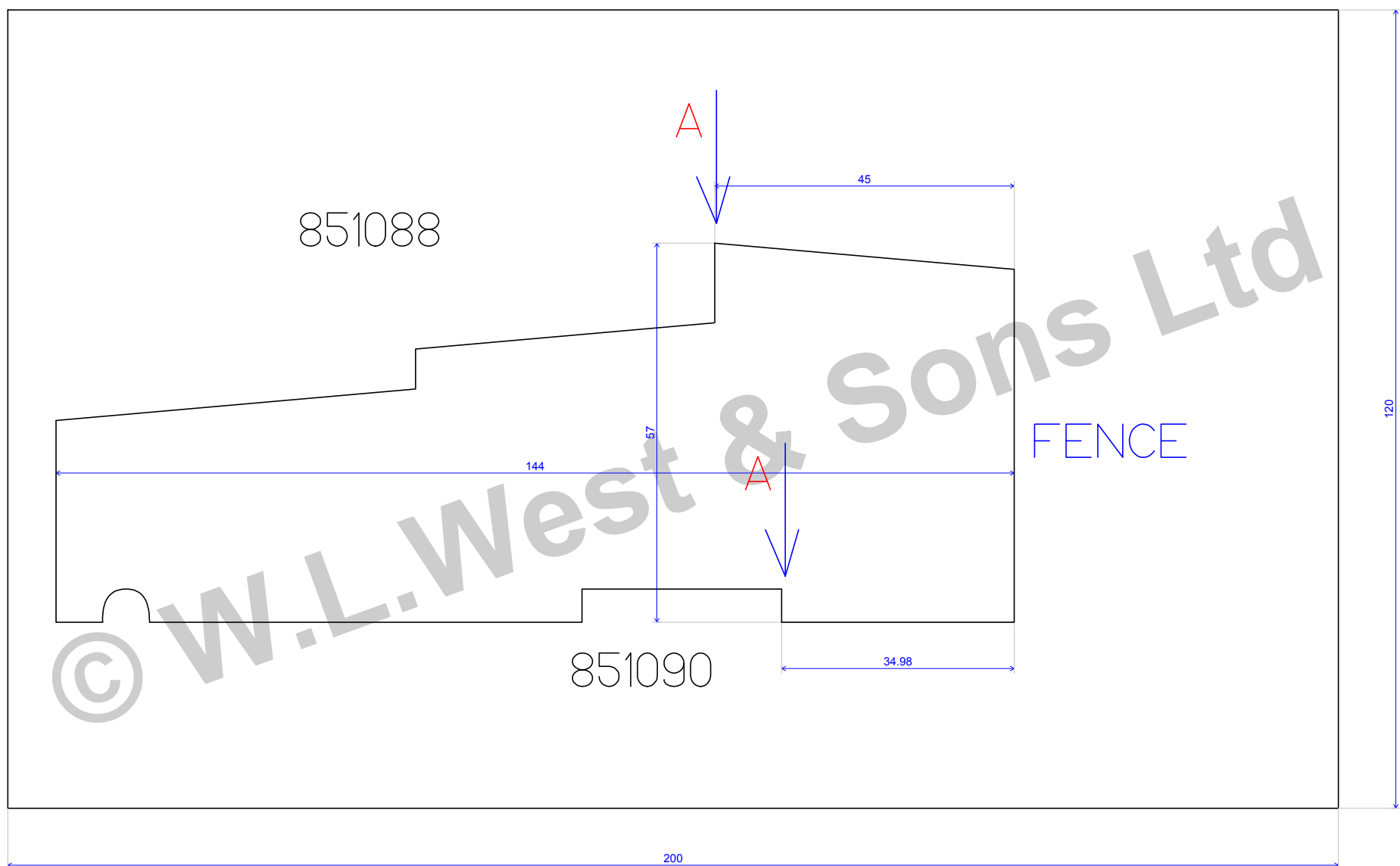

		
	WLW HEAD CILL SECTION G	Scale : 1.164
15/06/09	Box 851	

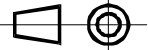
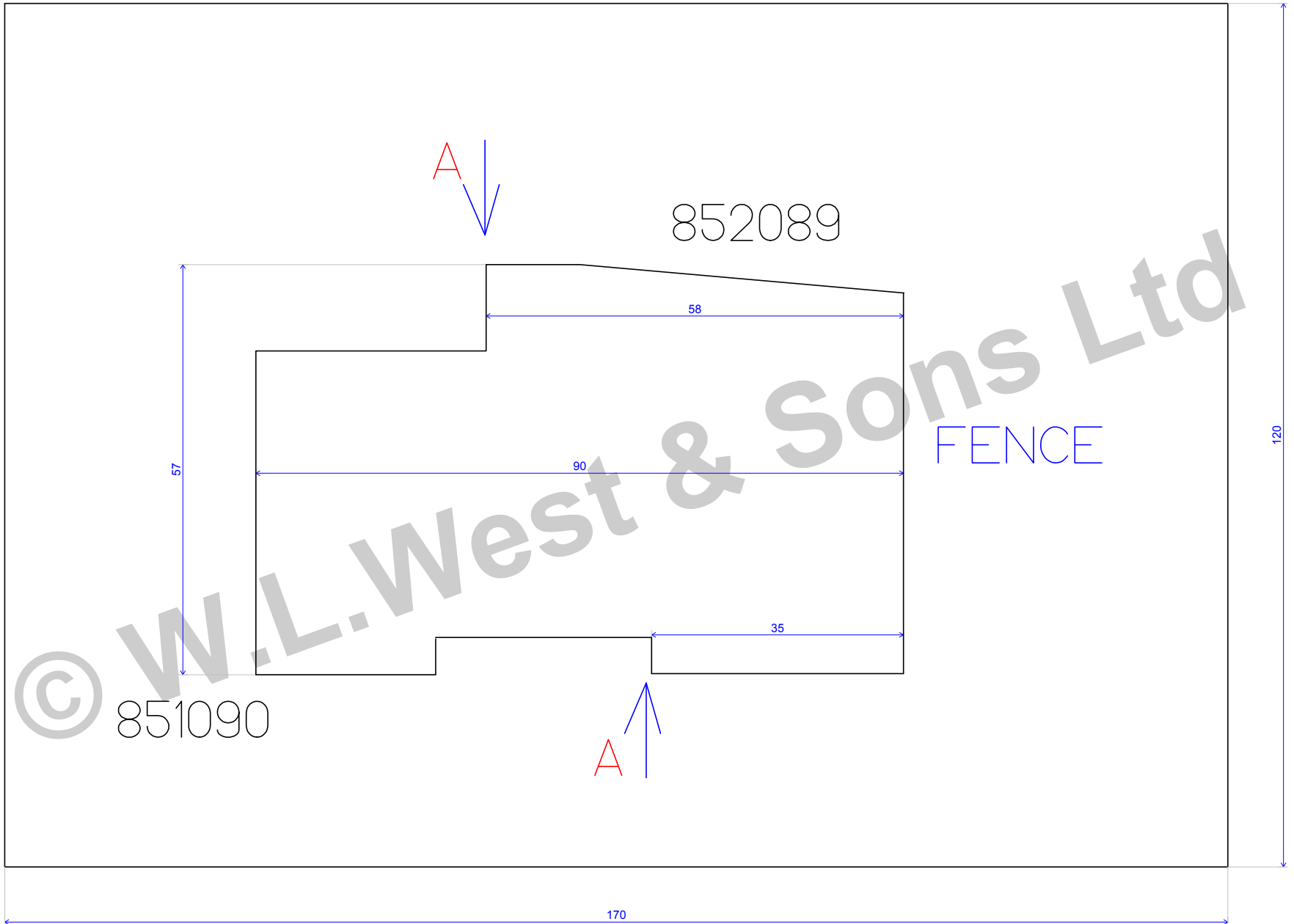

	WLW HEAD SECTION A	Scale : 1.299
15/06/09	Box 852	

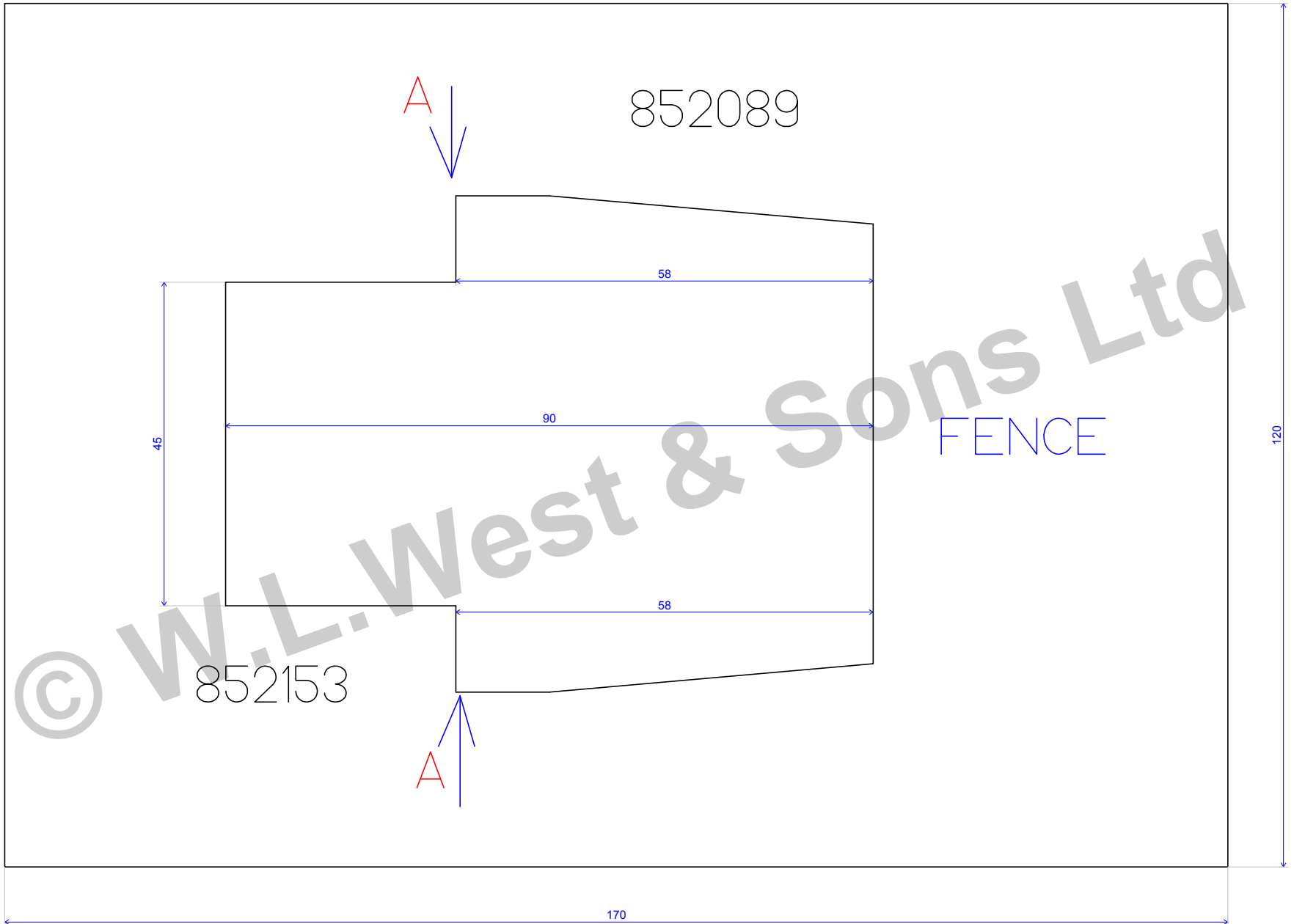

	WLW HEAD SECTION B	Scale : 1.299
15/06/09	Box 852	

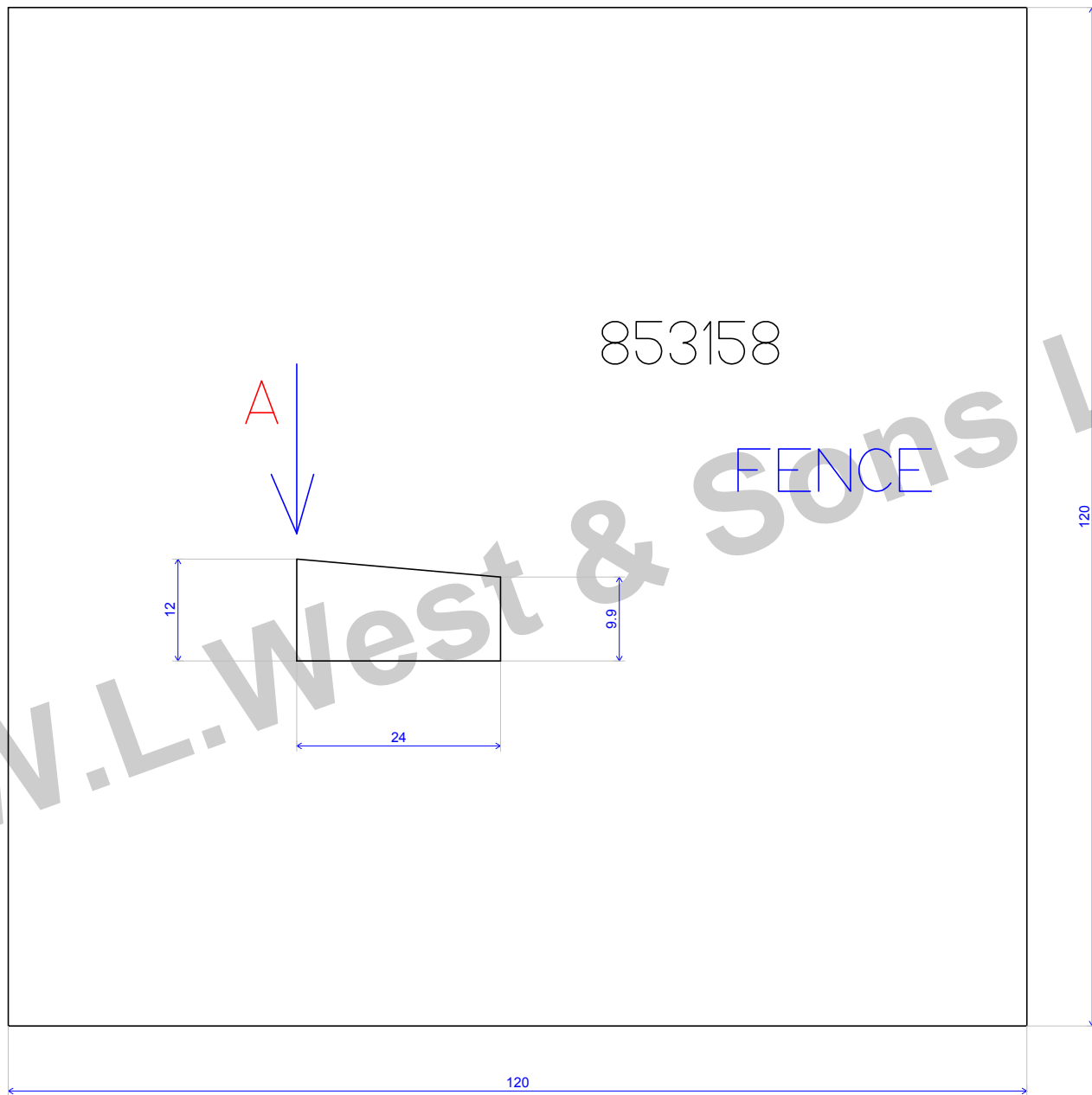

© W.L. West & Sons Ltd

	WLW HEAD SECTION D	Scale : 1.299
15/06/09	Box 853	

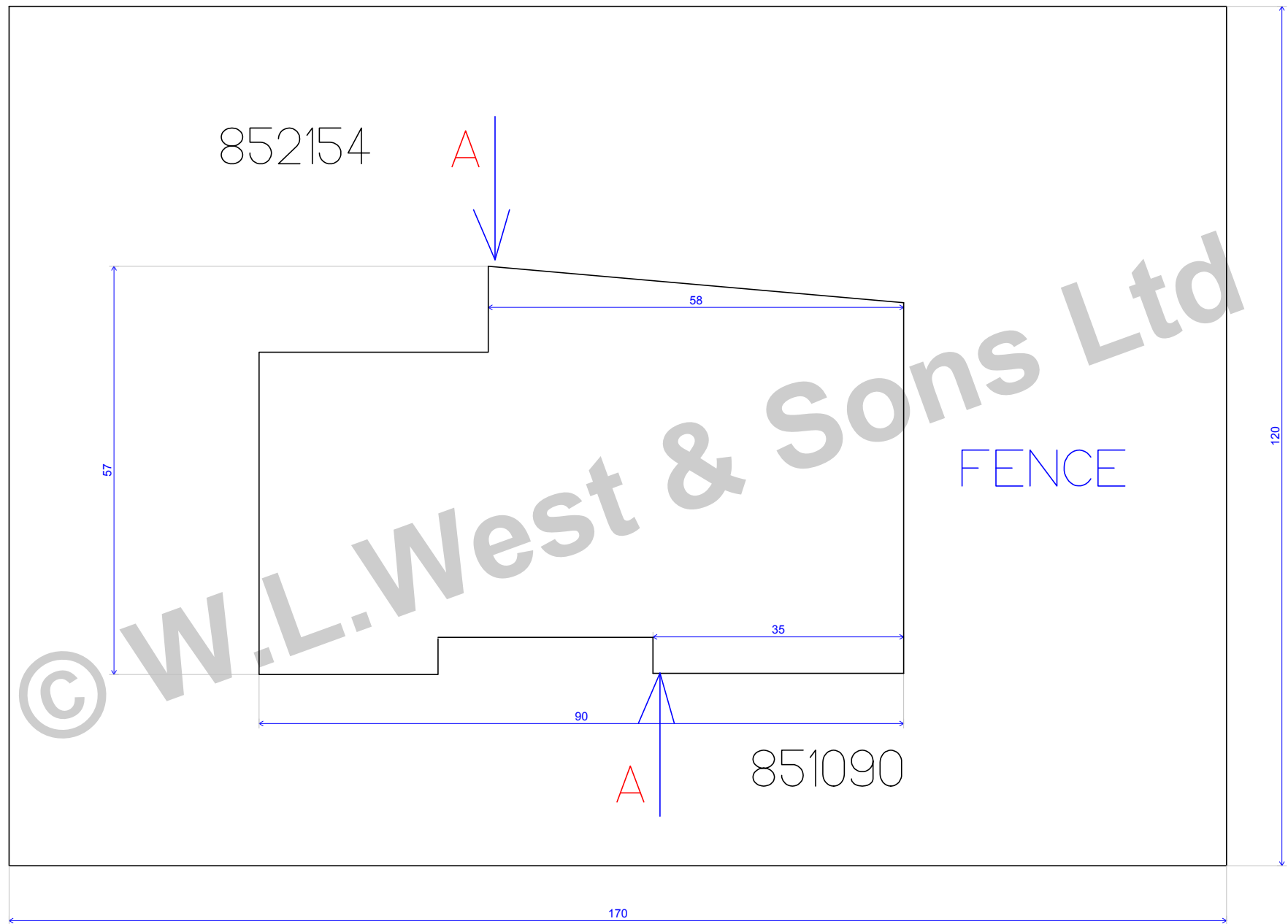

	WLW HEAD SECTION E	Scale : 1.299
15/06/09	Box 852	

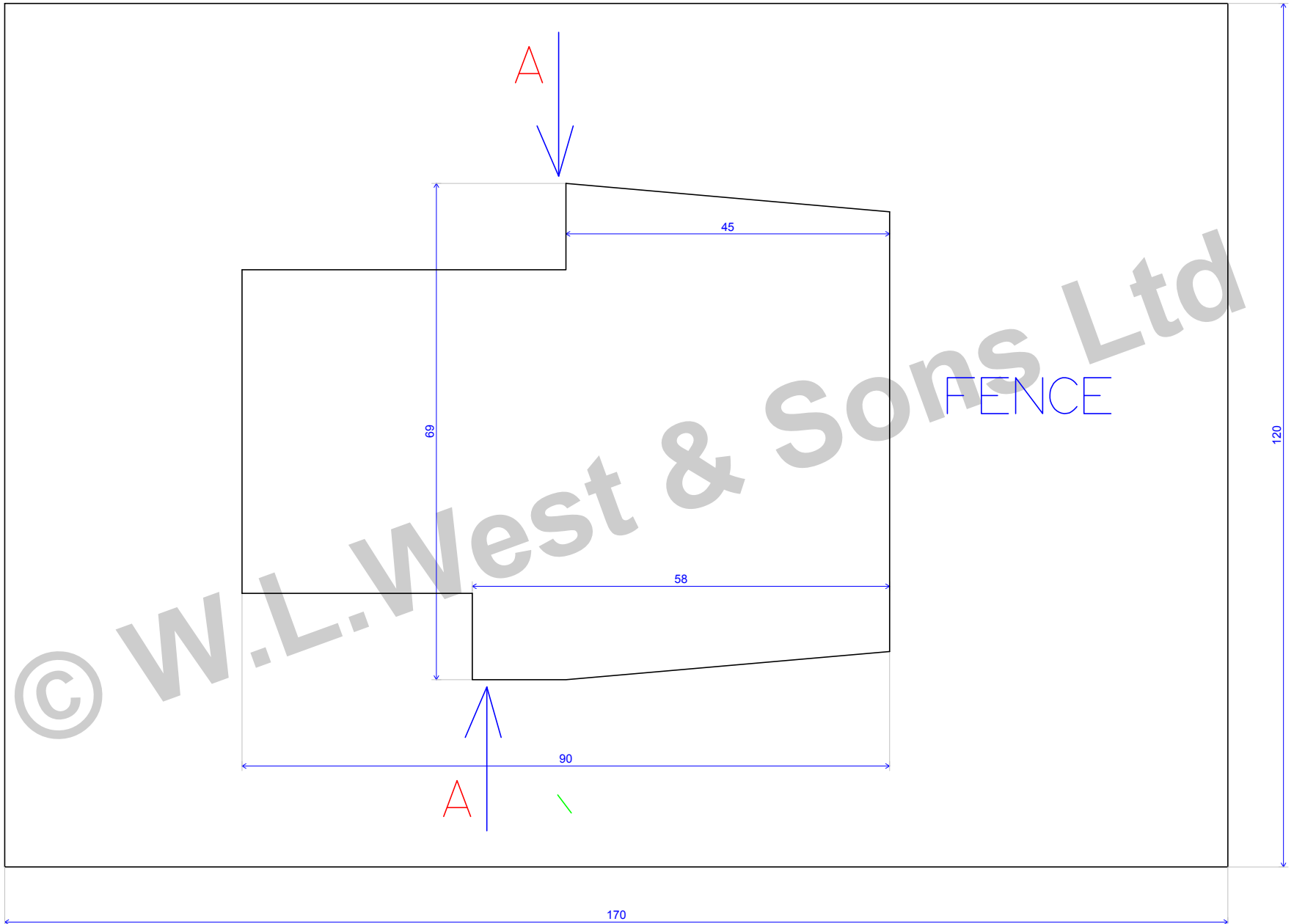

	WLW HEAD SECTION F	Scale : 1.299
15/06/09	Box 852	

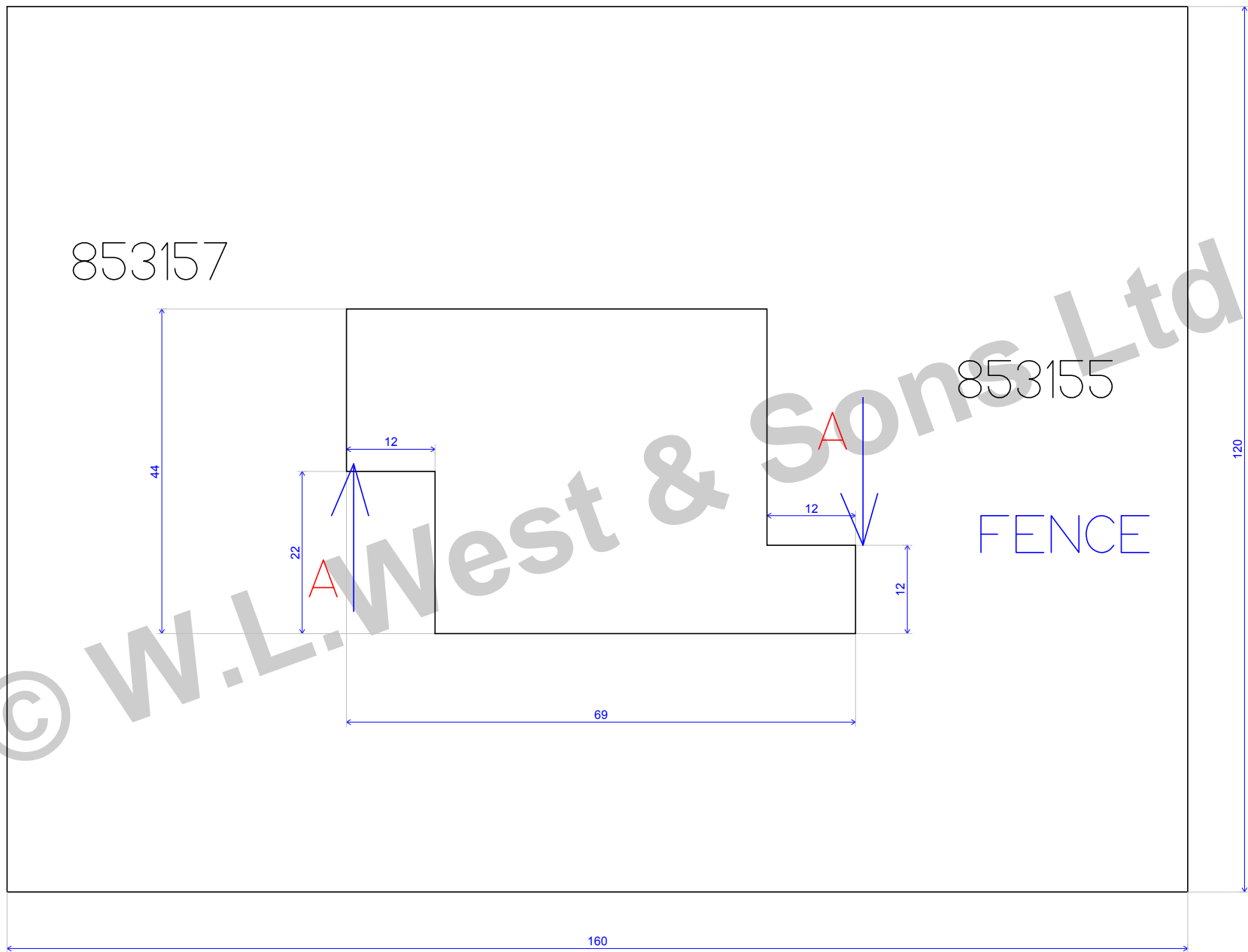

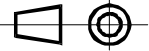
		
	WLW HEAD SECTION J	Scale : 1.299
15/06/09	Box 853	

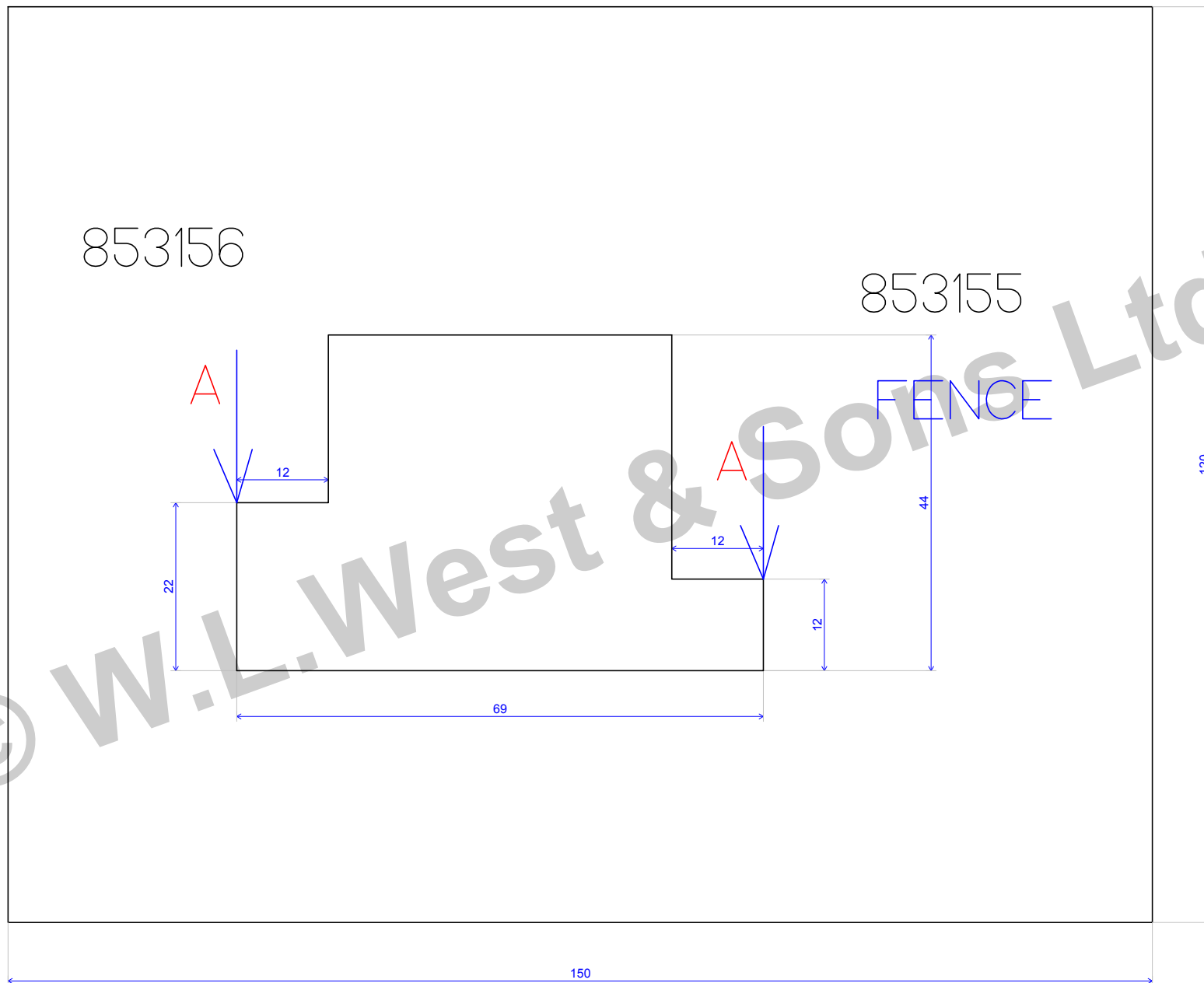

	WLW HEAD SECTION K	Scale : 1.299
15/06/09	Box 853	

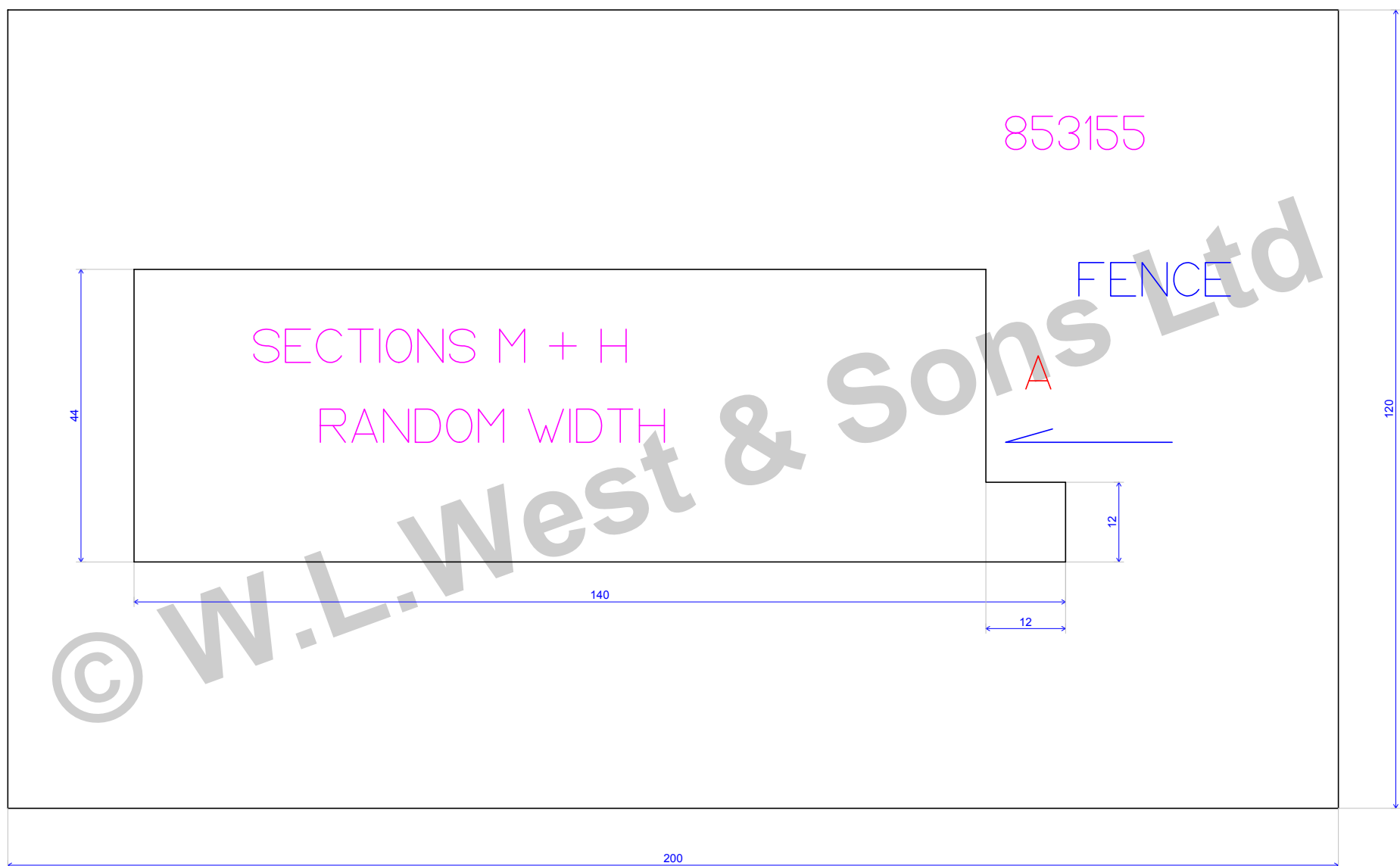

	WLW HEAD SECTION M & H	Scale : 1.164
15/06/09	Box 853	

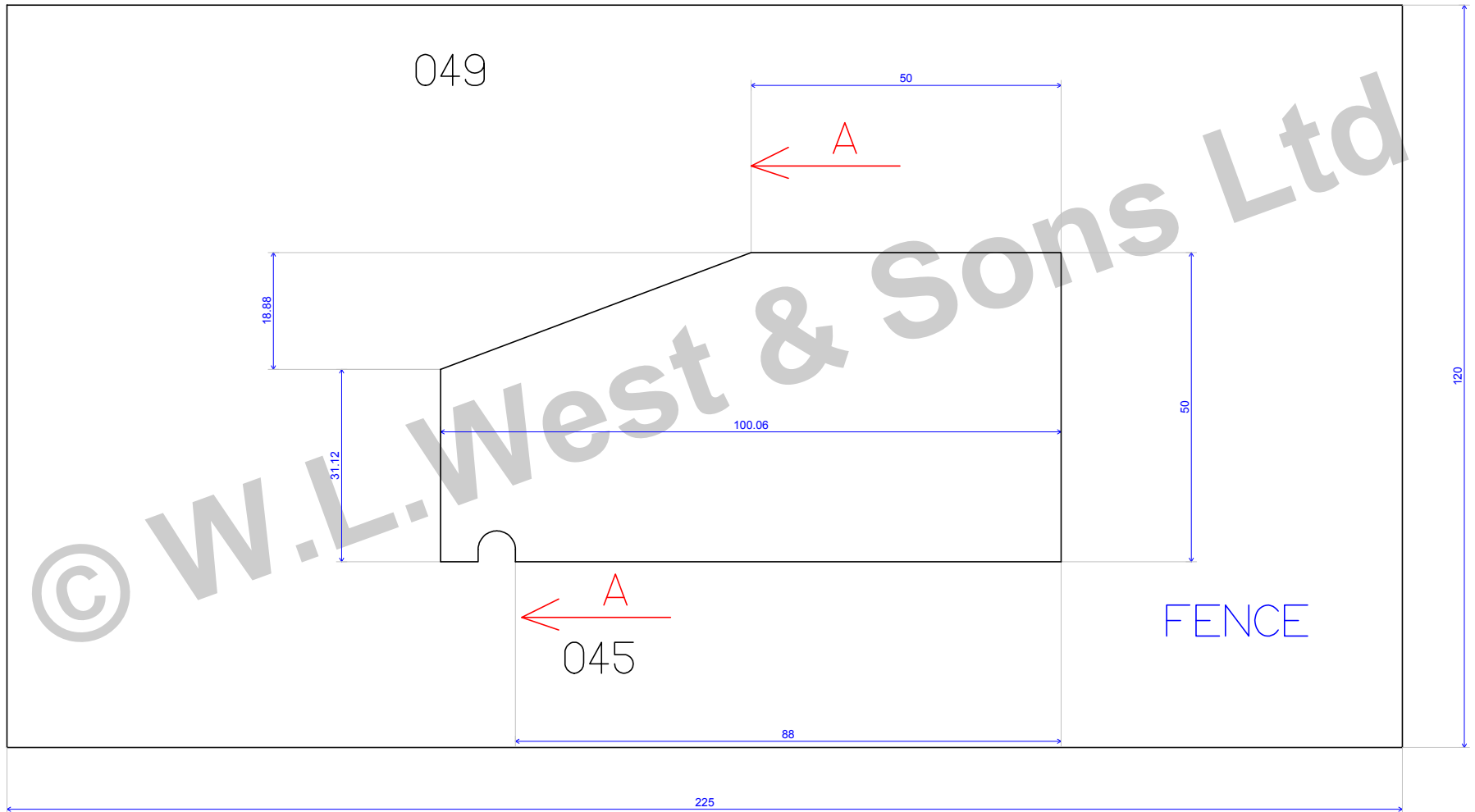

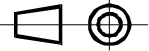
		
	WLW PATIO CILL SECTION 2	Scale : 1
16/06/09	Box 218 A	

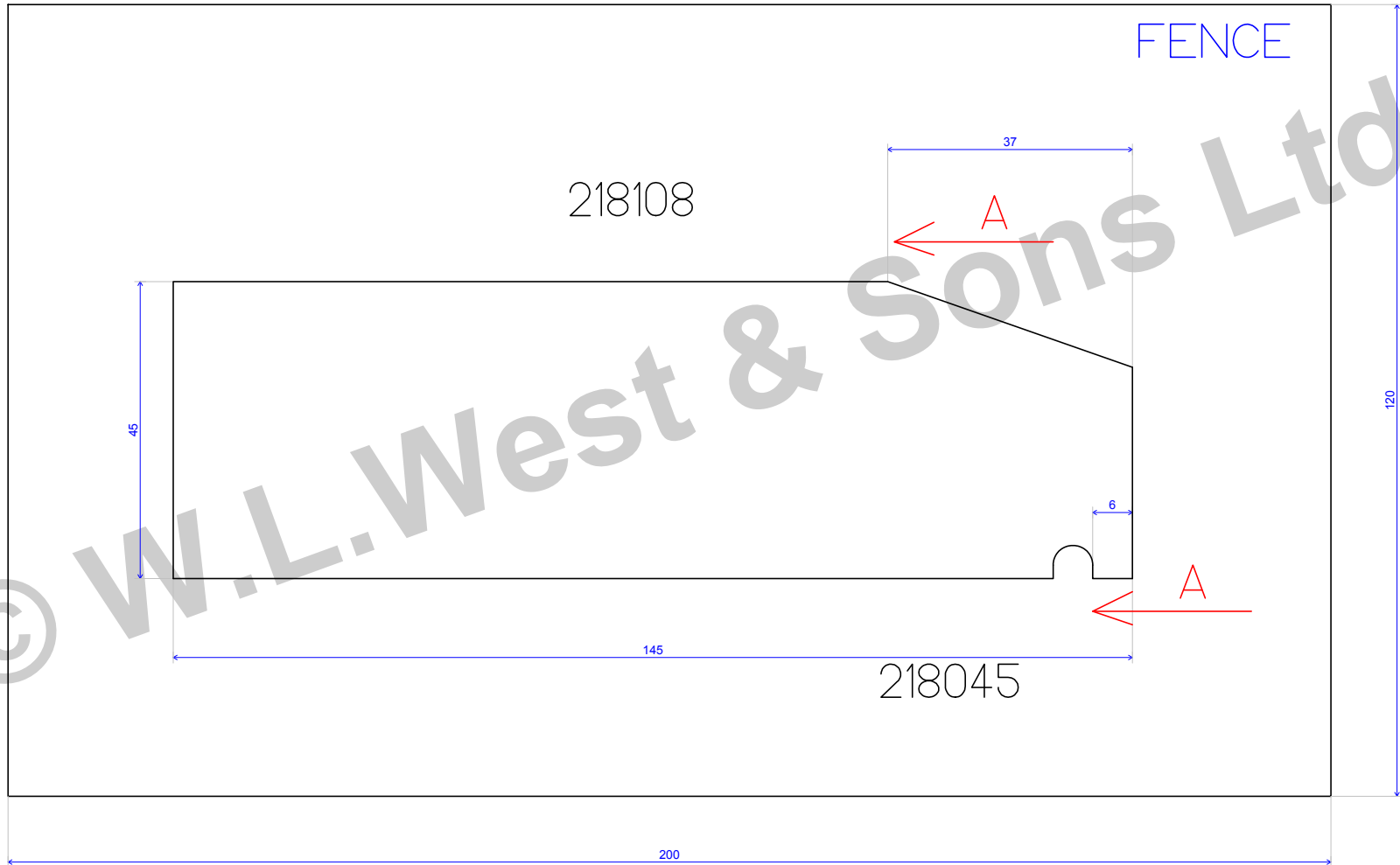

	WLW PATIO CILL SECTION	Scale : 1
16/06/09	Box 218	

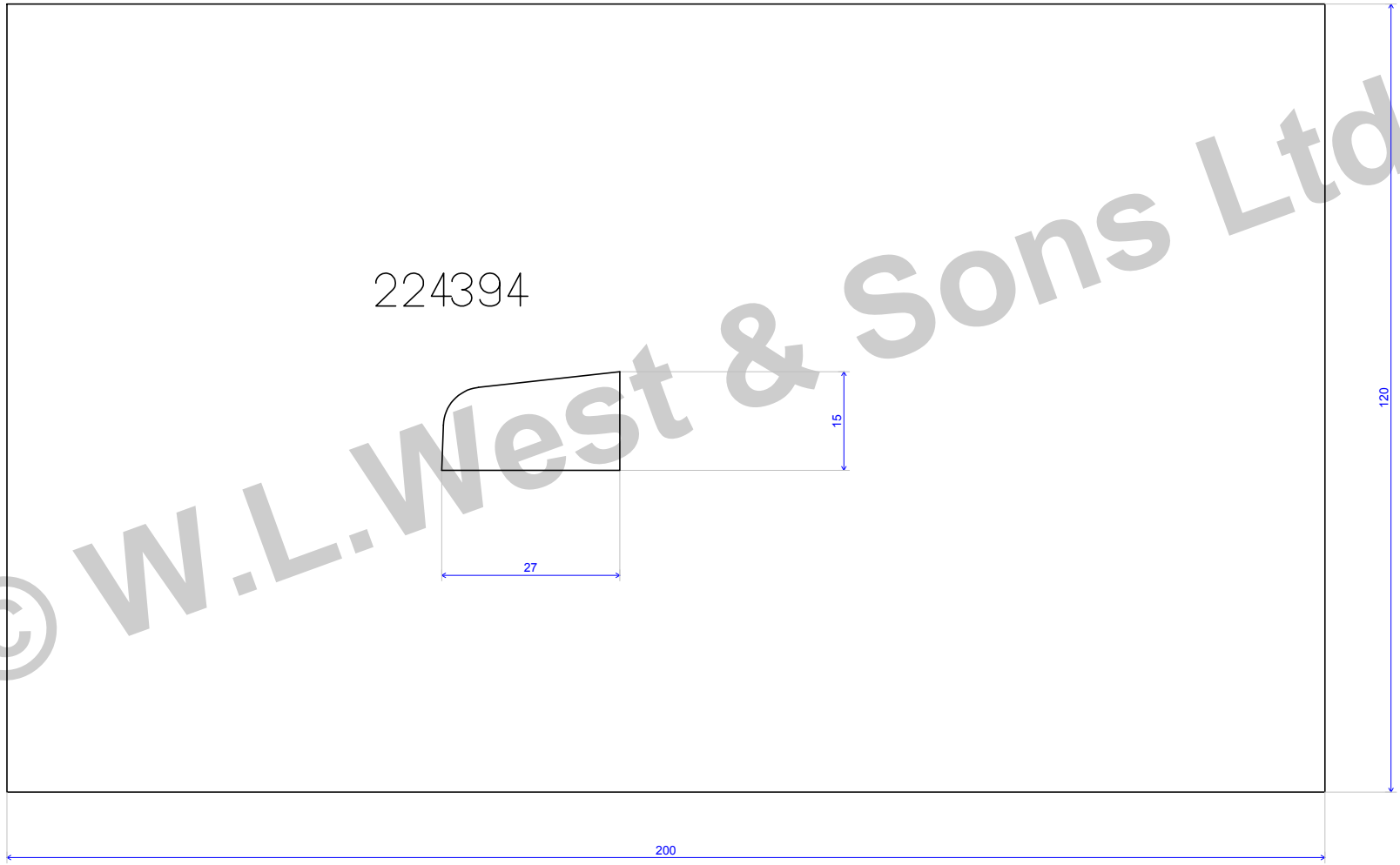

	WLW WINDOW BEAD	Scale : 1
16/06/09	Box 224	