

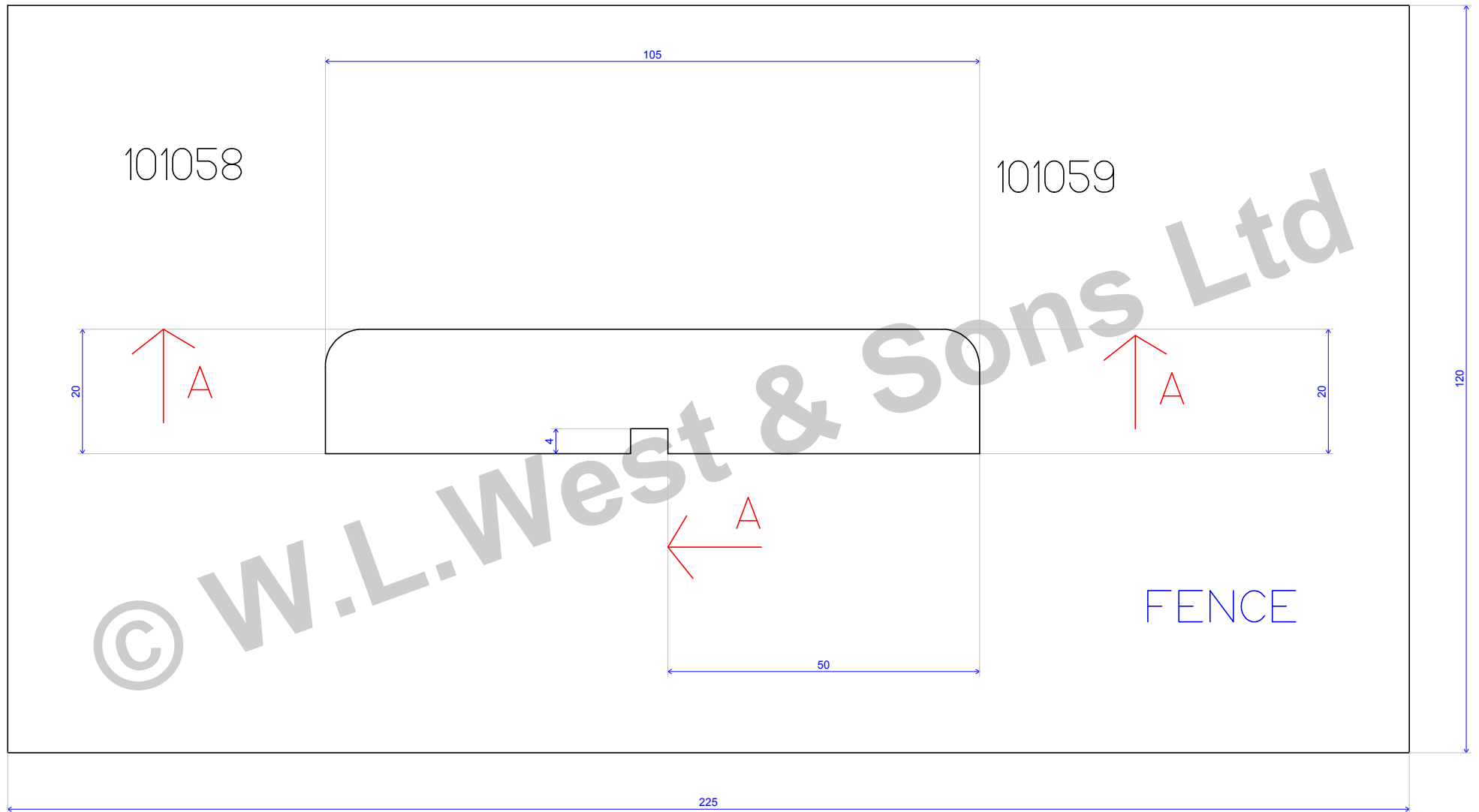

	<b>WLW 2 x 12MM RADIUS DECKING</b>	Scale : 1.235
20/05/09		



© W.L. West & Sons Ltd

	<b>WLW 2 x 6MM RADIUS DECKING</b>	Scale : 1.098
20/05/09	Box 101	

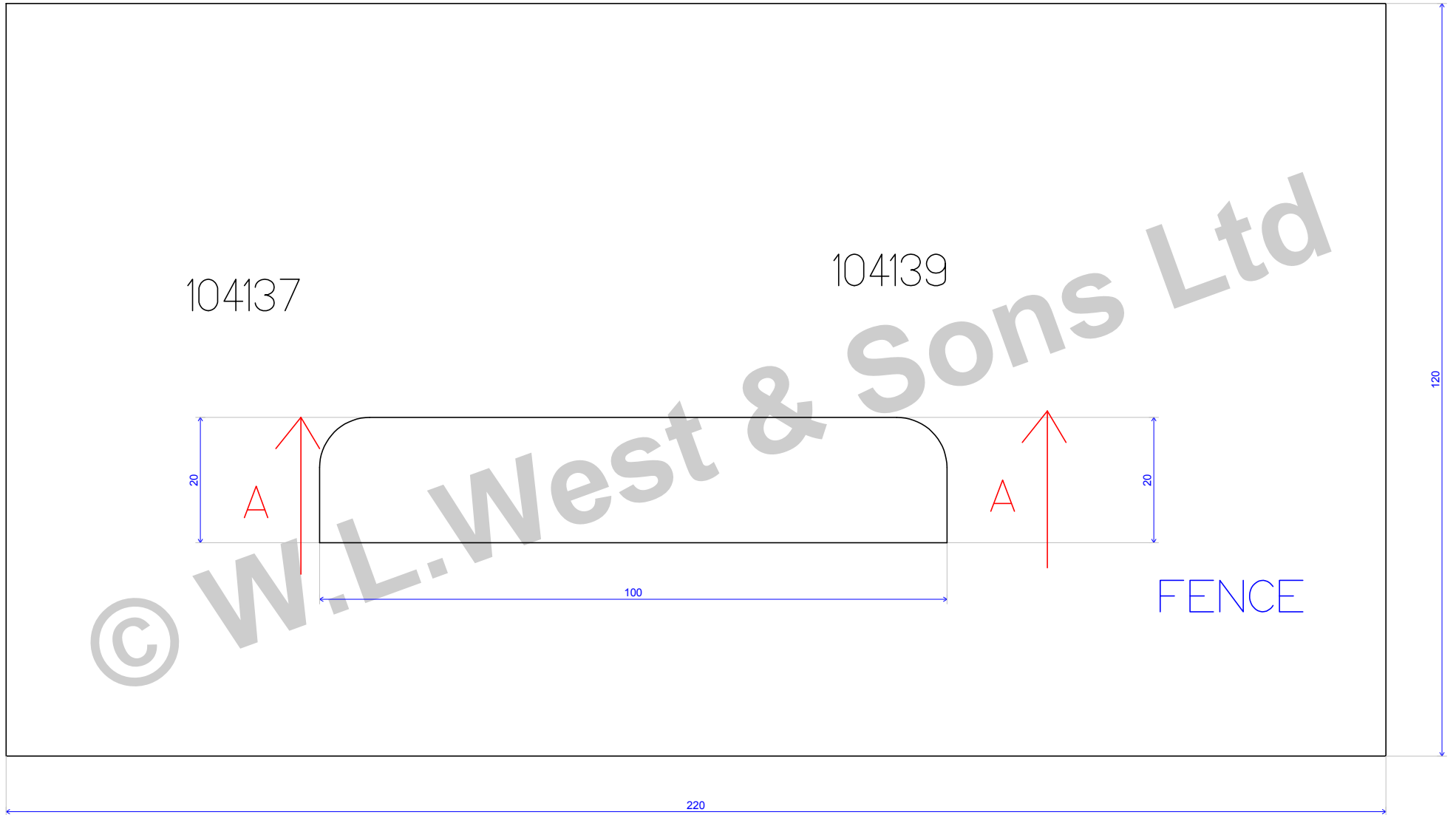

	<b>WLW 2 x 8MM RADIUS DECKING</b>	Scale : 1.123
20/05/09	Box 104	

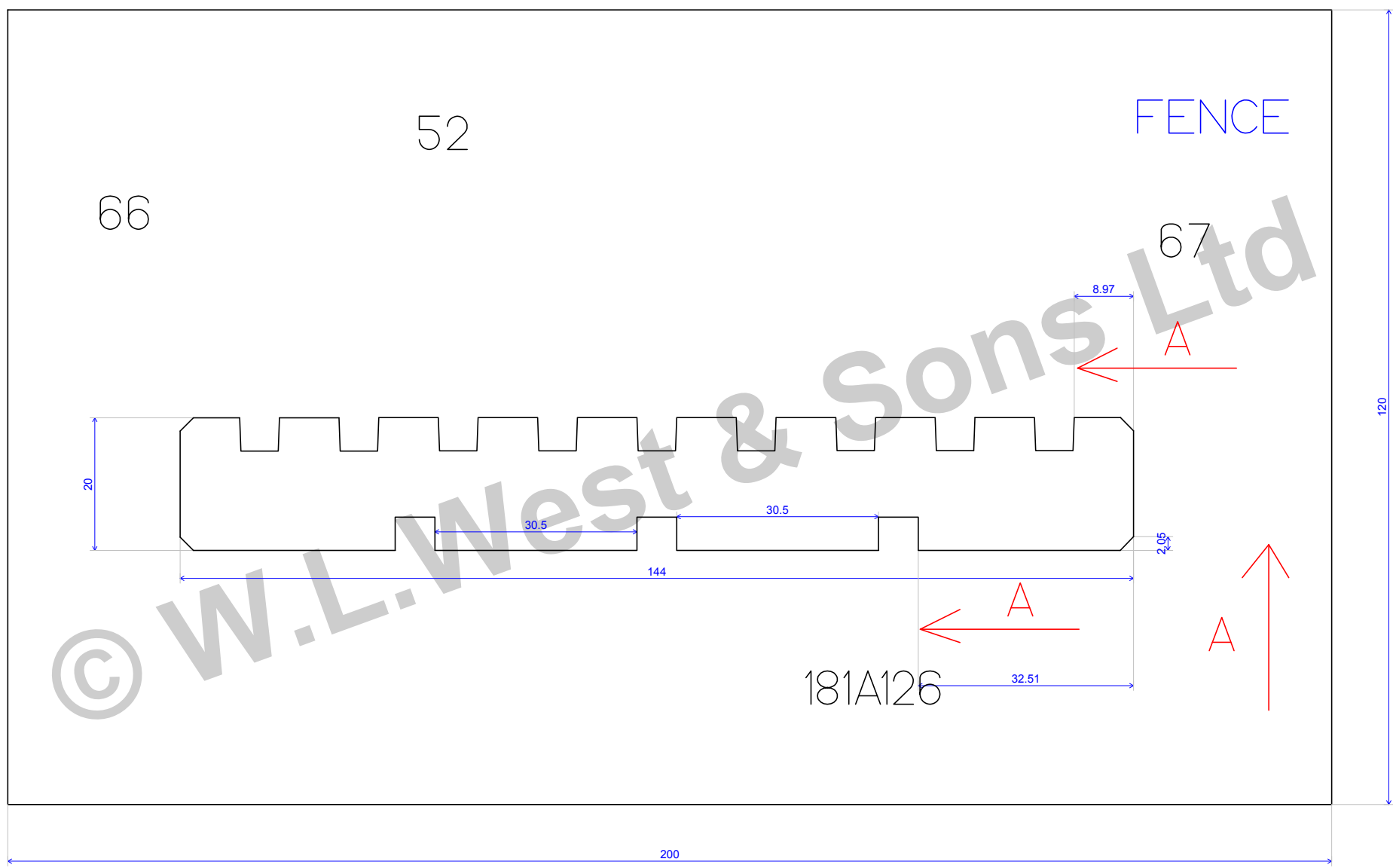

	<b>WLW 9 GROOVE DECK</b>	Scale : 1.164
20/05/09	Box 181 A	

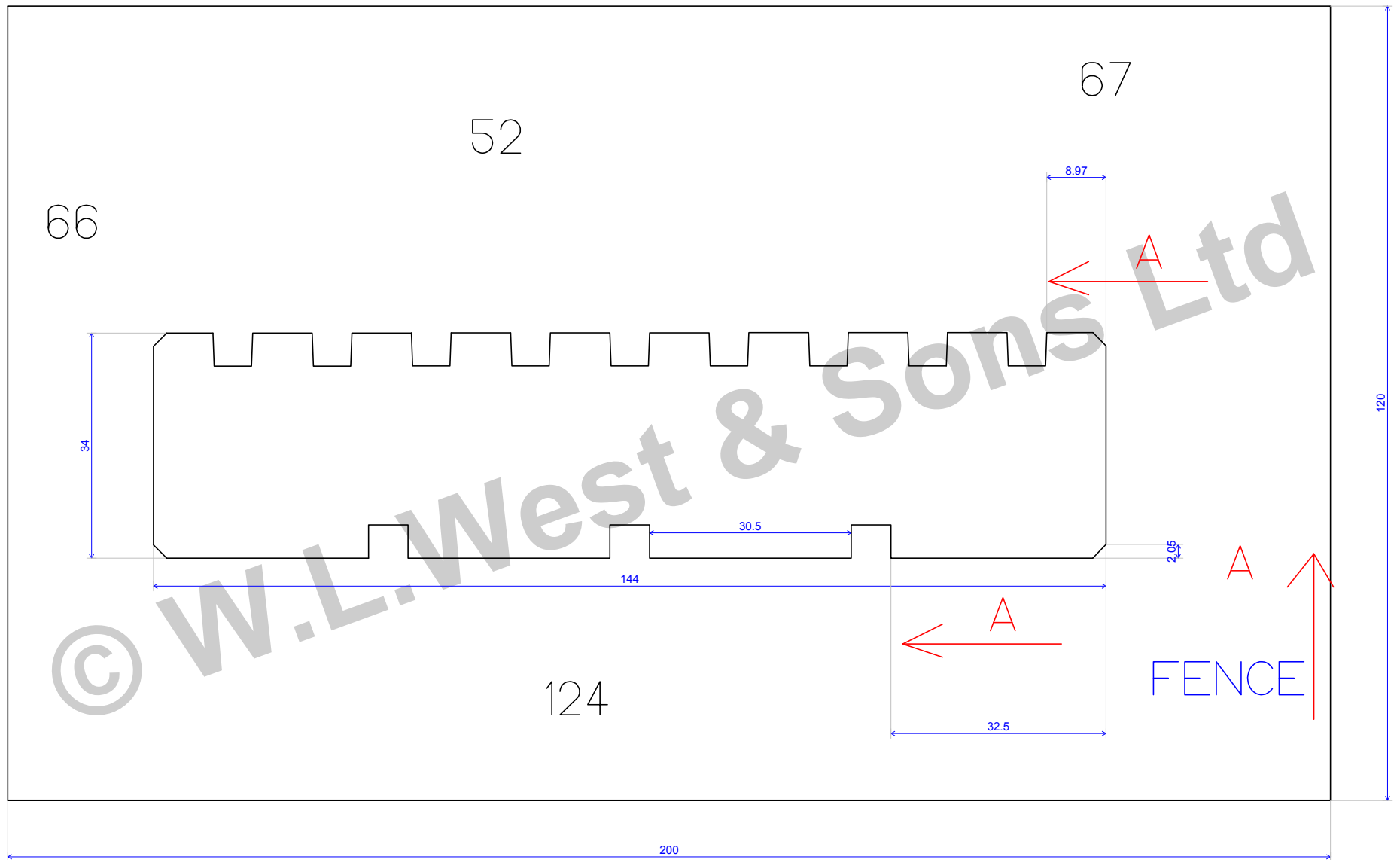

	<b>WLW 9 GROOVE DECK</b>	Scale : 1.164
20/05/09	Box 181 C	

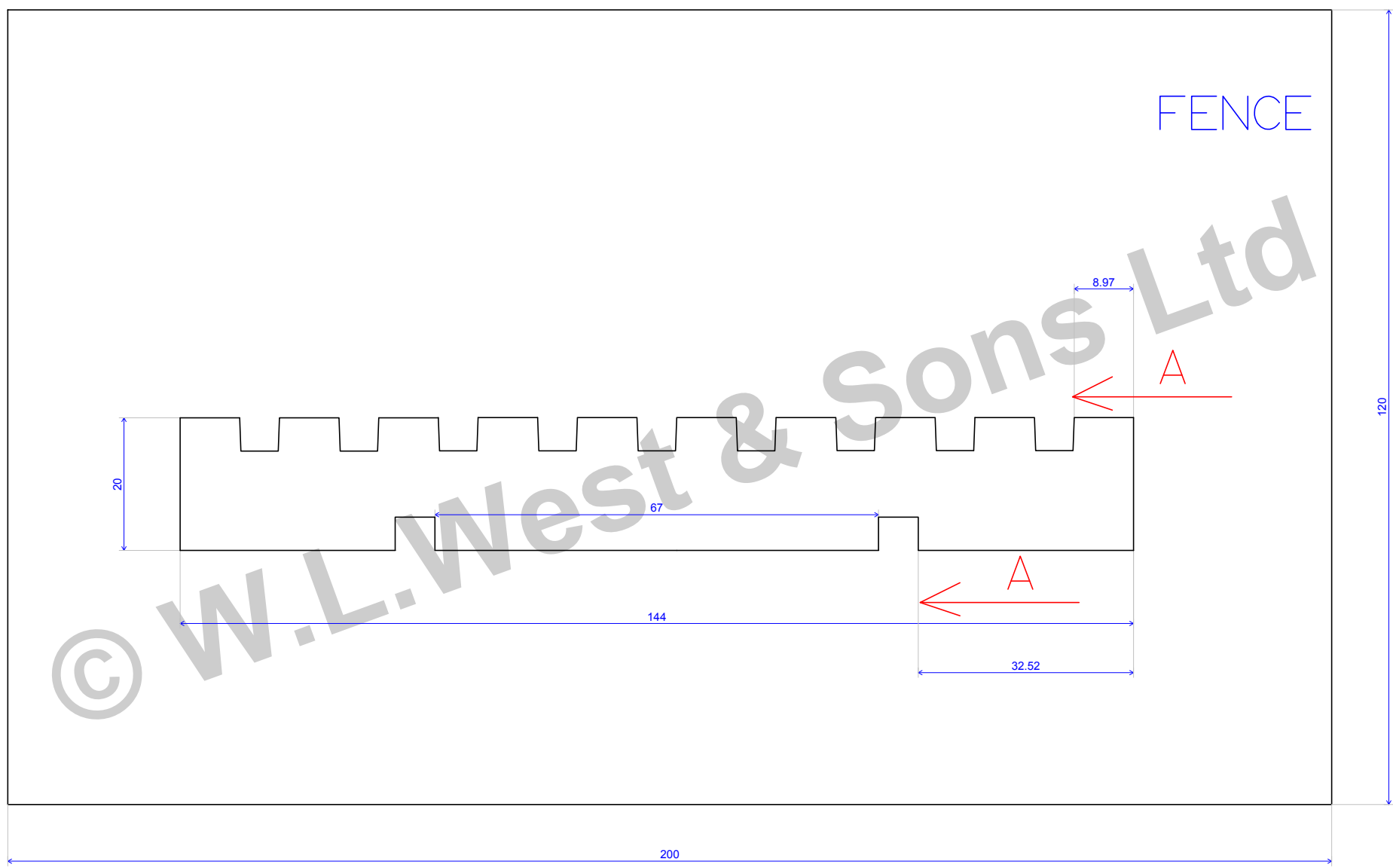

© W.L. West & Sons Ltd

FENCE

	<b>WLW 9 GROOVE DECK</b>	Scale : 1.164
20/05/09	Box 181	

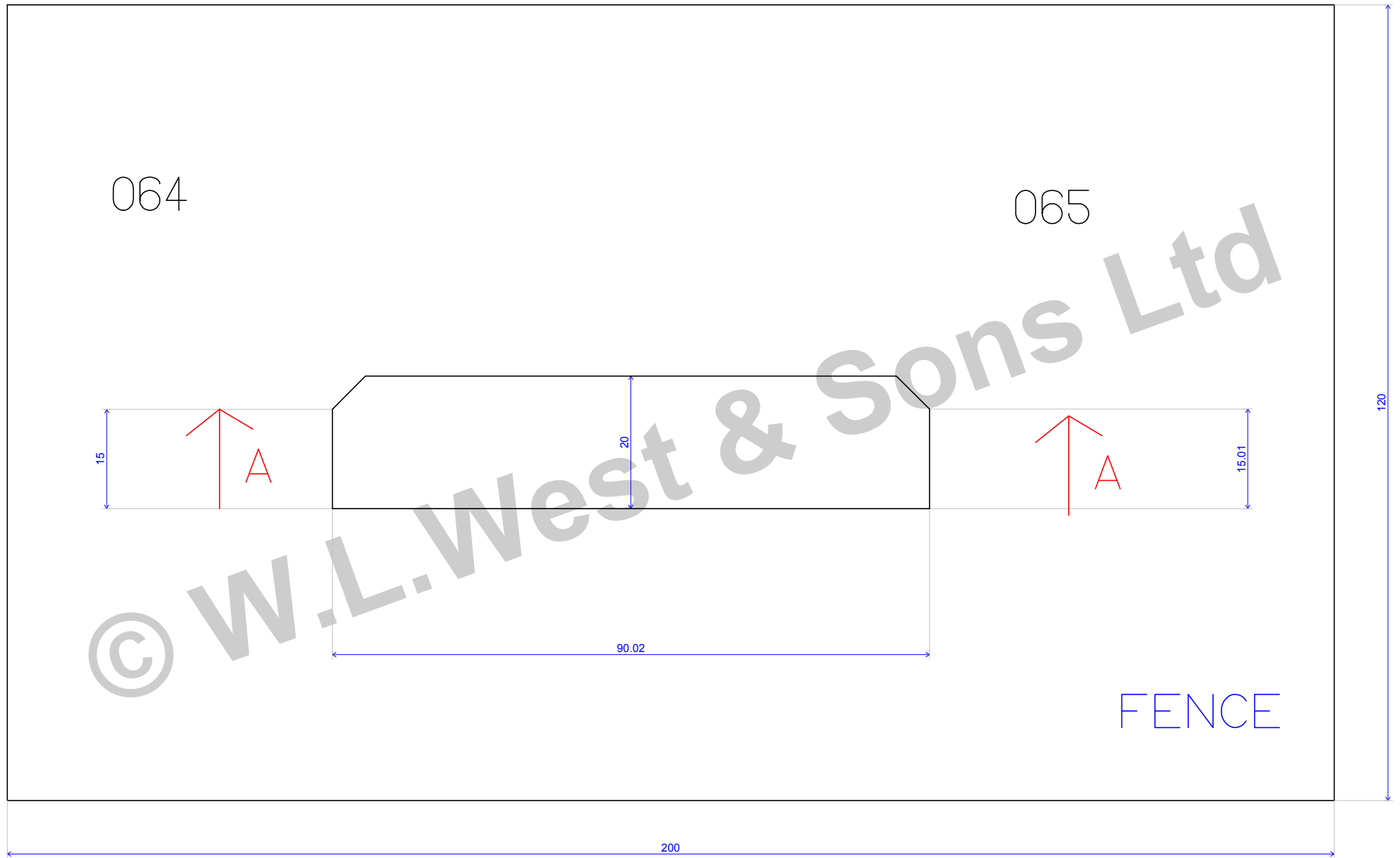

		
	<b>WLW CHAMPH DECK</b>	Scale : 1.235
19/05/09		

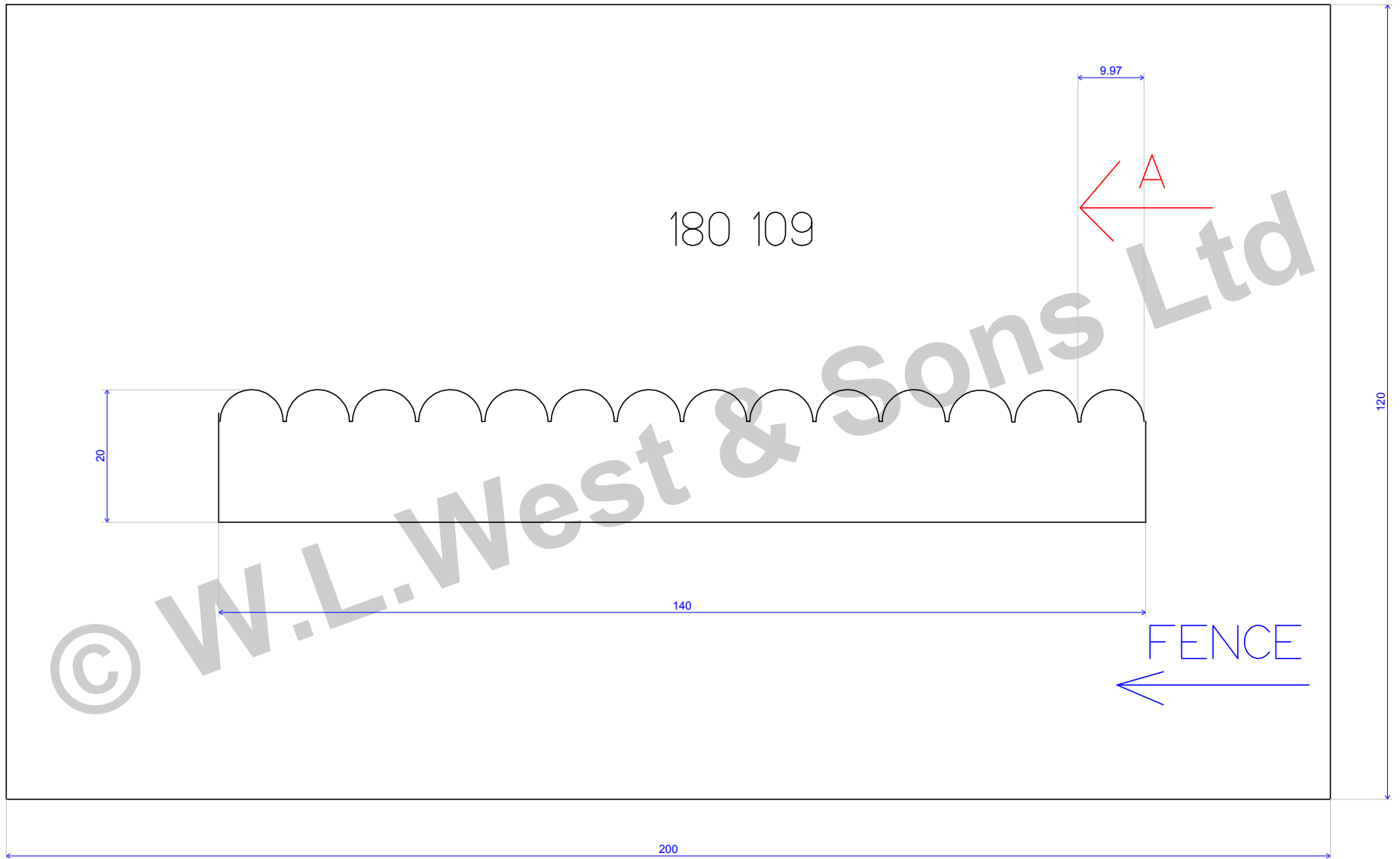

		
	<b>WLW CHAMPH DECK 1</b>	Scale : 1.164
19/05/09	Box 180	



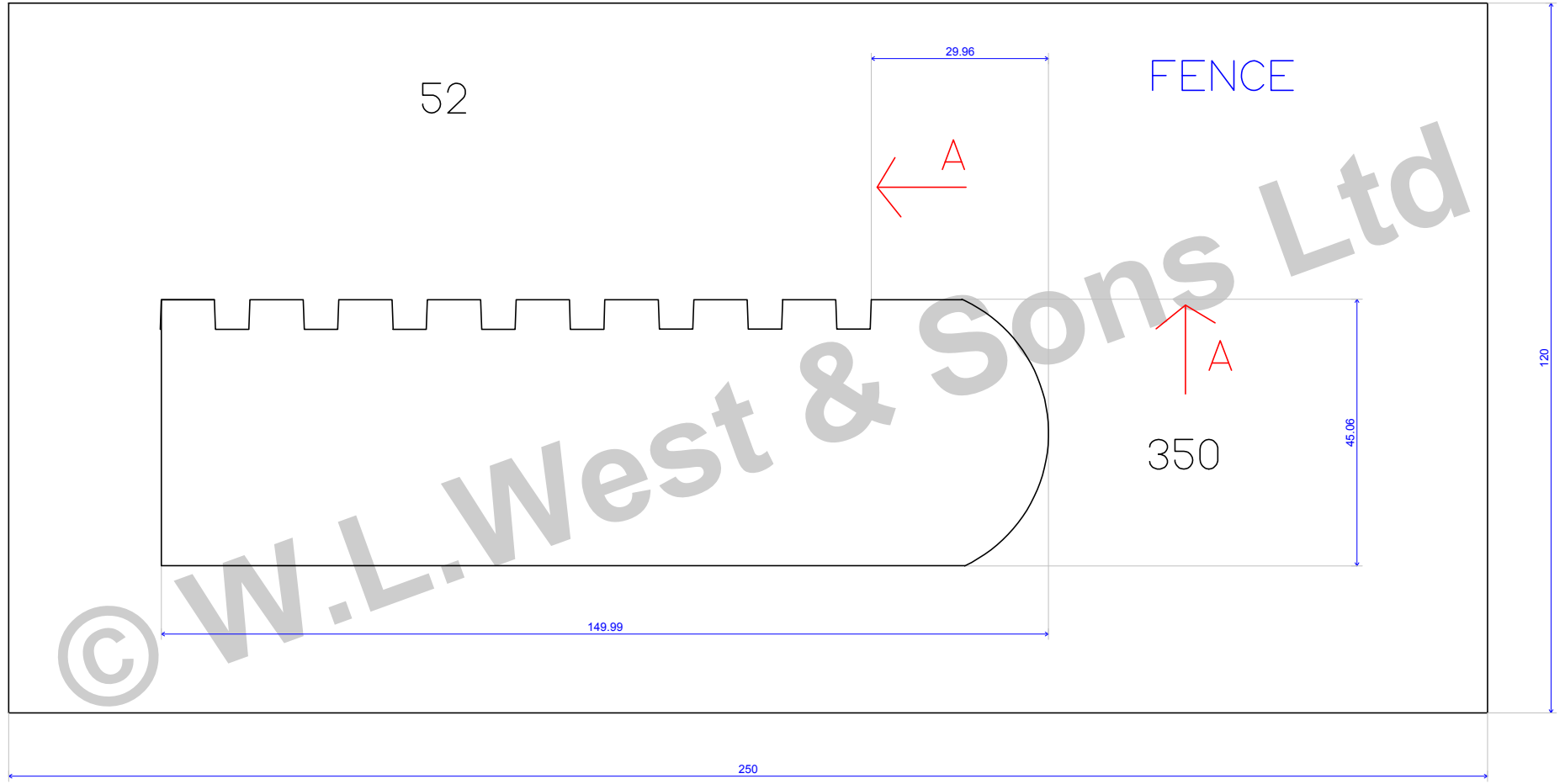

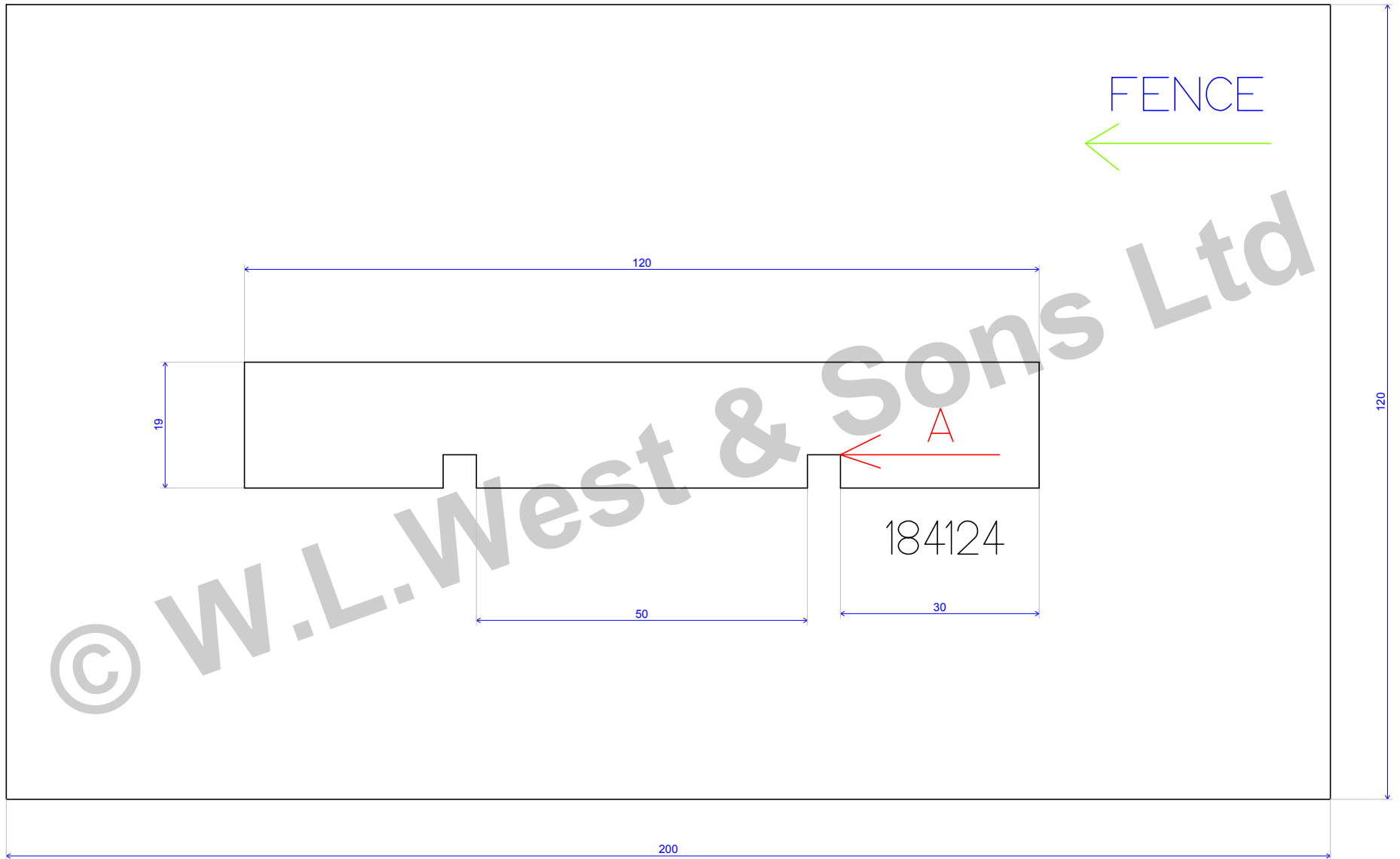

	<b>WLW 9 GROOVE STEP</b>	Scale : 0.931
20/05/09	Box 179	

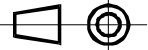

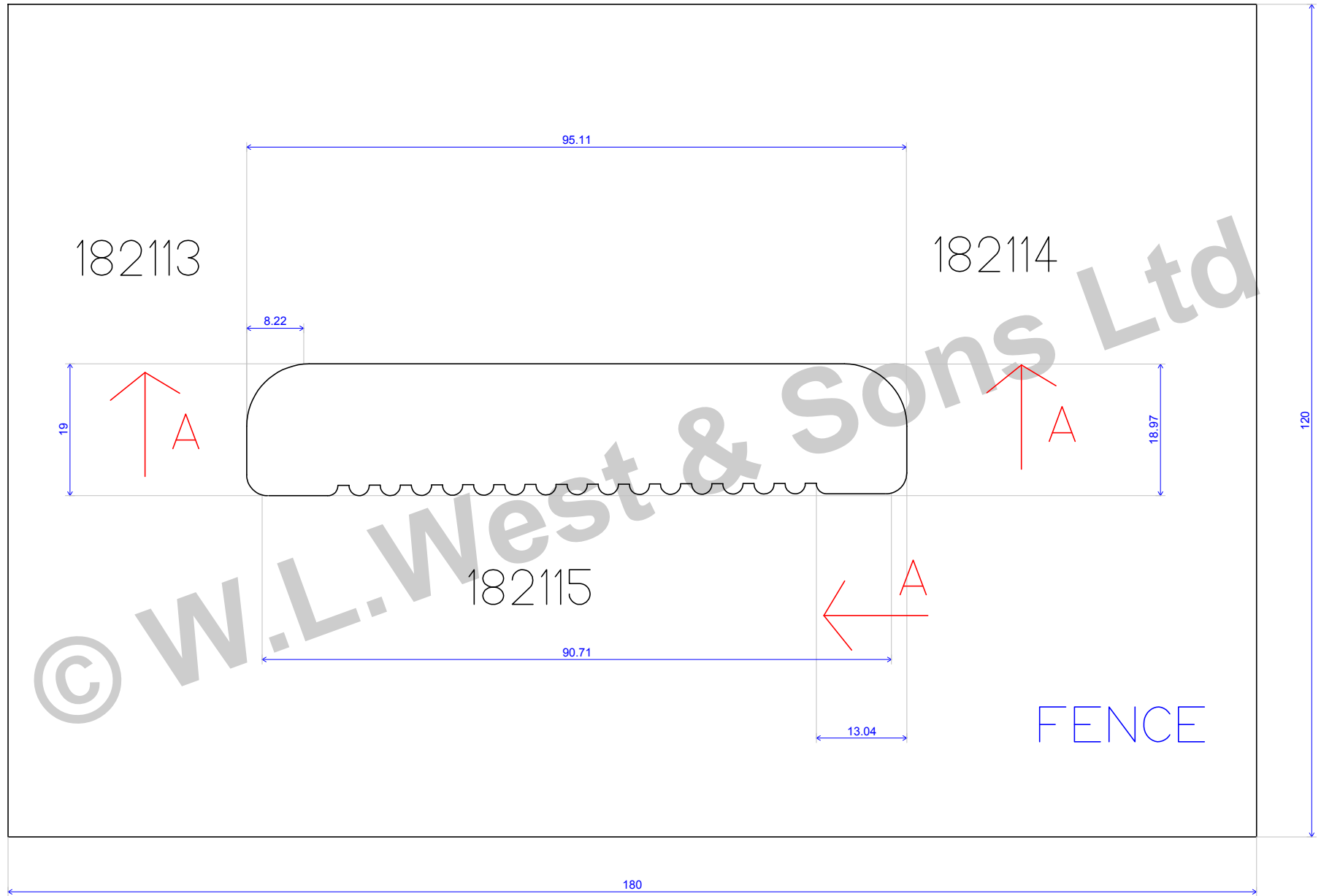
		
	<b>WLW PLAIN DECK</b>	Scale : 1.164
20/05/09	Box 184	



		
	<b>WLW SMALL RIDGE DECK 2</b>	Scale : 1.257
19/05/09		